

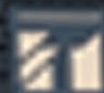

HX-5 Series

Variable Dispersion Speaker System

New innovations in sound reinforcement.

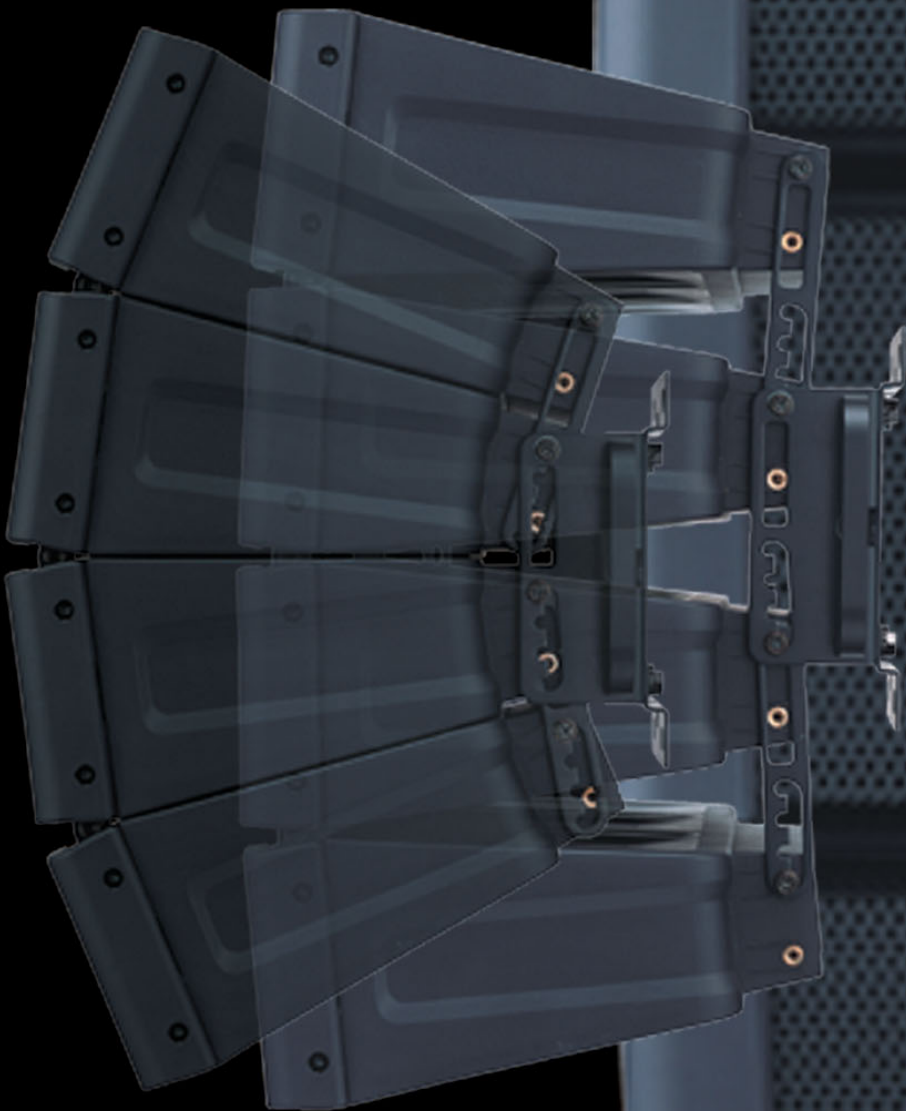

safe&sound



HX Series — Full area coverage

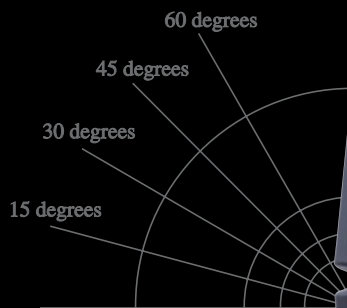

TOA's new HX-5 Series Speaker System fills an important need for versatile public address equipment that can provide high quality reinforcement for a wide range of venues. Available in black and white finishes to complement a venue's interior color scheme, the HX-5 Series is ideal for a wide range of medium size

venues of all different shapes that often pose problems for sound reinforcement. These include auditoriums, places of worship, banquet halls, community centers as well as dance halls, sports bars, shopping malls, boardrooms, gyms, health clubs and many others.



HX-5B / HX-5B-WP

Design background

The HX-5 is an innovative modular speaker design that incorporates the best characteristics of the traditional, cumbersome woofer enclosure combined with a CD horn-loaded high frequency driver and the full-range compact speaker enclosure without the drawbacks associated with each type.

The traditional speaker system was able to provide well-controlled sound coverage but posed various difficulties for correct installation and also presented an old-fashioned appearance as well that impacts on the venue's appearance. The full-range compact speaker enclosure is easy to install, but the design's sound coverage is hard to control.

The HX-5 features remarkably easy to control coverage characteristics including problematic low frequencies and can be installed in a multitude of ways while maintaining a modern, unobtrusive appearance.

Directivity
changeable
speaker

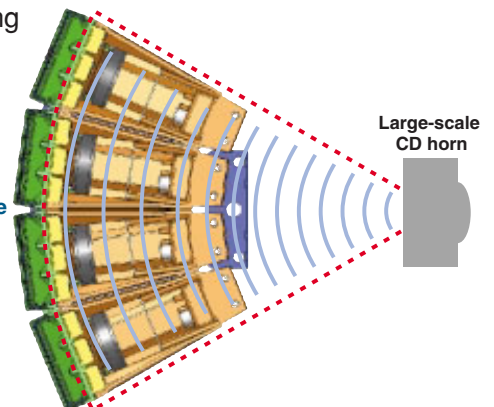

e and wider bandwidth sound.

Adjustable sound dispersion

The HX-5 Series offers a variable dispersion angle that can be adjusted for 60, 45, 30 and 15 degrees to suit venue acoustic requirements. The modular design allows combining units to achieve a better variable dispersion-controlled frequency range, increasing low frequency output.

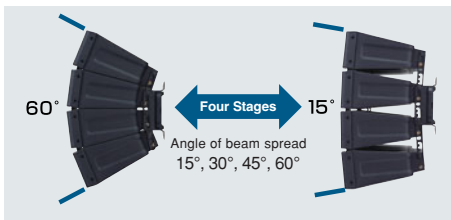

When you arrange the plural

In multiple unit configurations, the HX-5 will be able to deliver greater low frequency output over its angle of dispersion.

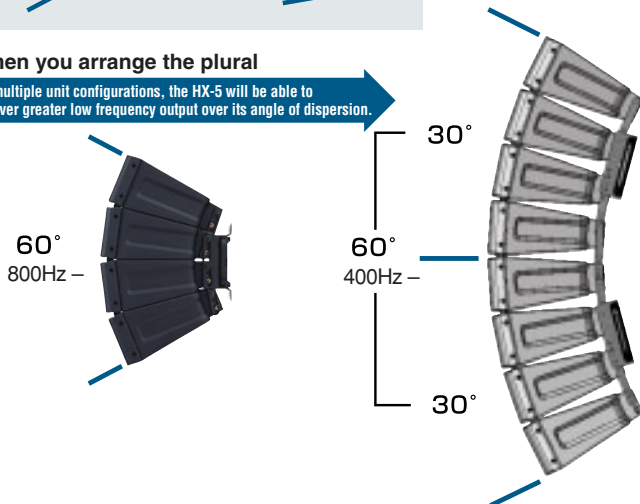

Minimal reflective effects

Whether mounted on the wall or ceiling, the HX-5 is remarkably free from the comb filter and interference effects often encountered with other speaker designs. It can therefore produce more low frequency output even when mounted on the wall or ceiling.

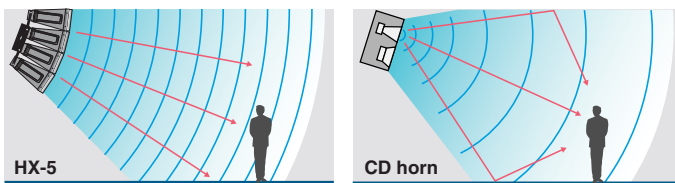

Versatile mounting options

Compared to many other speaker designs, the HX-5 Series is remarkably easy to install in several ways. It can be hung easily with chains, strong wires and cables using the accessory brackets. There are also options for hanging with a pre-install frame by itself or configured with a subwoofer. There are also other options including ceiling and wall brackets as well as an adapter for use with a dedicated stand.

Transformer option

The HX-5 Series can also be used with a MT-200 matching transformer.

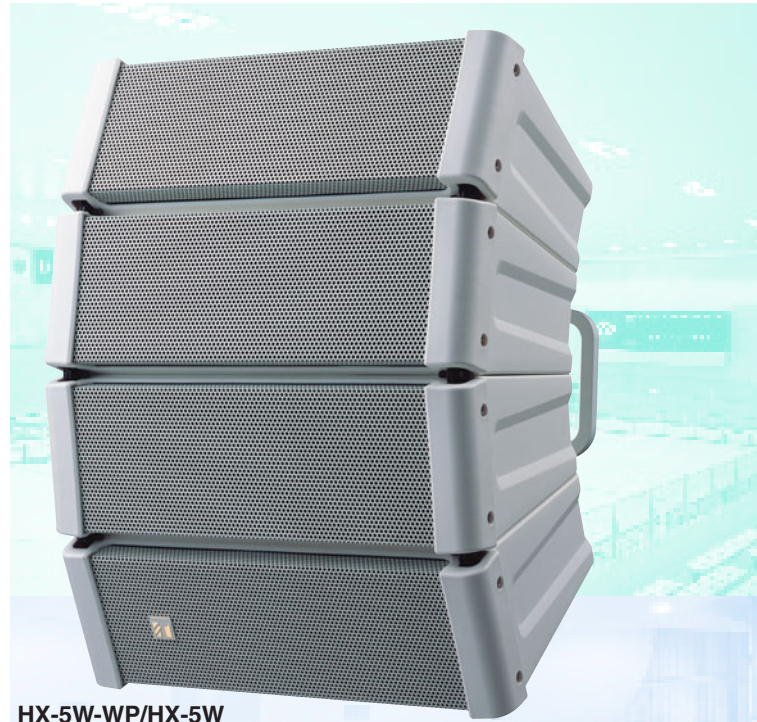

HX-5W-WP/HX-5W



FB-120B

FB-120W

Sub Woofer



















SPECIFICATIONS

	HX-5B	HX-5B-WP	HX-5W	HX-5W-WP
Enclosure	Bass-reflex type	Sealed type	Bass-reflex type	Sealed type
Power Handling Capacity	Continuous pink noise: 200W, Continuous program: 600W			
Rated Impedance	8Ω			
Sensitivity	96dB (60° mode), 97dB (45° mode), 98dB (30° mode), 99dB (15° mode)*			
Frequency Response	70 – 20,000Hz (–10dB) (60° mode), 75 – 20,000Hz (–10dB) (45° mode), 80 – 20,000Hz (–10dB) (30° mode), 85 – 20,000Hz (–10dB) (15° mode)		95 – 20,000Hz (–10dB) (60° mode), 100 – 20,000Hz (–10dB) (45° mode), 105 – 20,000Hz (–10dB) (30° mode), 110 – 20,000Hz (–10dB) (15° mode)	
Crossover Frequency	4kHz			
Directivity Angle	Horizontal: 100° (over 2000Hz) Vertical: 60° (over 800Hz), 45° (over 1.2kHz), 30° (over 1.6kHz), 15° (over 3.2kHz) variable			
Speaker Component	Low frequency: 12cm cone-type × 4 High frequency: Balanced dome-type × 12			
Input Connector	Speakeron NL4MP x 2 and M4 screw terminal	—	Speakeron NL4MP x 2 and M4 screw terminal	—
Speaker Cord	—	2-core cabtyre cord with diameter of 6mm	—	2-core cabtyre cord with diameter of 6mm
Water Protection	—	IPX4 (Install with the every speaker module downward)	—	IPX4 (Install with the every speaker module downward)
Operating Temperature	–15°C to +50°C			
Finish	Enclosure: Polypropylene, black	Polypropylene, white	Polypropylene, black	Polypropylene, white
Dimensions	408 (W) × 546 (H) × 342 (D)mm			
Weight	16kg			
Accessory	Hanging bracket × 2, Hex. wrench × 1			
Option	Matching transformer: MT-200 Speaker mountind bracket: HY-PF1B, HY-CW1B, HY-WM1B, HY-WM2B, HY-CN1B Speaker stand adapter: HY-ST1	MT-200 HY-PF1WP, HY-CW1WP, HY-WM1WP, HY-WM2WP, HY-CN1B-WP	MT-200 HY-PF1W, HY-CW1W, HY-WM1W, HY-WM2W, HY-CN1W HY-ST1	MT-200 HY-PF1WP, HY-CW1WP, HY-WM1WP, HY-WM2WP, HY-CN1W-WP

* (Factory-preset: 60° mode)

	FB-120B	FB-120W
Power Handling Capacity	Continuous pink noise: 200W, Continuous program: 600W	
Rated Impedance	8Ω	
Sensitivity	90dB (1W, 1m) of installation in free sound field 96dB (1W, 1m) of installation in 1/2 free sound field	
Frequency Response	40 – 1,200Hz (–10dB)	
Speaker Component	30cm cone-type	
Input Connector	Speakon NL4MP x 2 and M4 screw terminal, distance between barriers:11mm	
Finish	Enclosure: Plywood Panched net: Steel plate, black, paint	Plywood Steel plate, white, paint
Dimensions	408 (W) × 408 (H) × 450 (D)mm	
Weight	15kg	
Option	Speaker rigging frame: HY-PF1B	Speaker rigging frame: HY-PF1W

Optional Accessories

 HY-PF1B Rigging Frame for indoor use	 HY-CW1B Ceiling Mounting Bracket for indoor use	 HY-WM1B Mounting Bracket for indoor use	 HY-WM2B Mounting Bracket for indoor use	 HY-CN1B Extension Bracket for indoor use	 HY-CN1W Extension Bracket for indoor use
 HY-PF1W Rigging Frame for indoor use	 HY-CW1W Ceiling Mounting Bracket for indoor use	 HY-WM2W Mounting Bracket for indoor use	 HY-WM1W Mounting Bracket for indoor use	 HY-CN1BWP Extension Bracket for outdoor use	 HY-CN1WWP Extension Bracket for outdoor use
 HY-PF1WP Rigging Frame for outdoor use	 HY-CW1WP Ceiling Mounting Bracket for outdoor use	 HY-WM2WP Mounting Bracket for outdoor use	 HY-WM1WP Mounting Bracket for outdoor use	 HY-ST1 Speaker Stand Adapter	 WT-200 Matching Transformer